

501: Uitbouw 1,2m

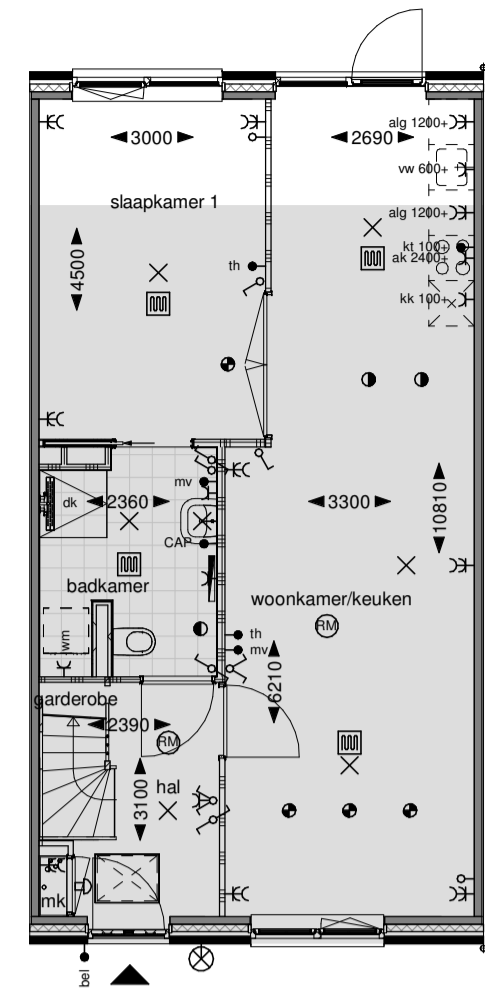

Begane grond

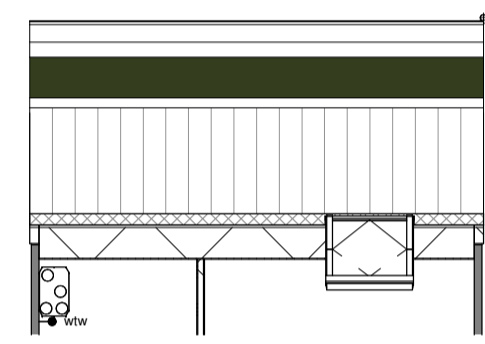

Eerste verdieping



Achtergevel

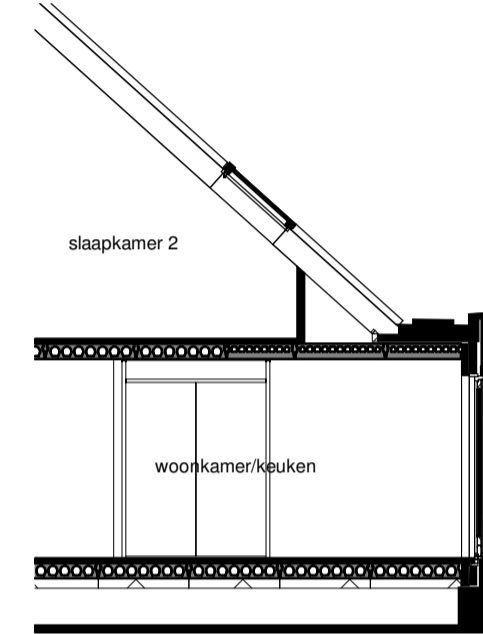

Doorsnede

531: Dakkapel voorgevel (b=1770mm)

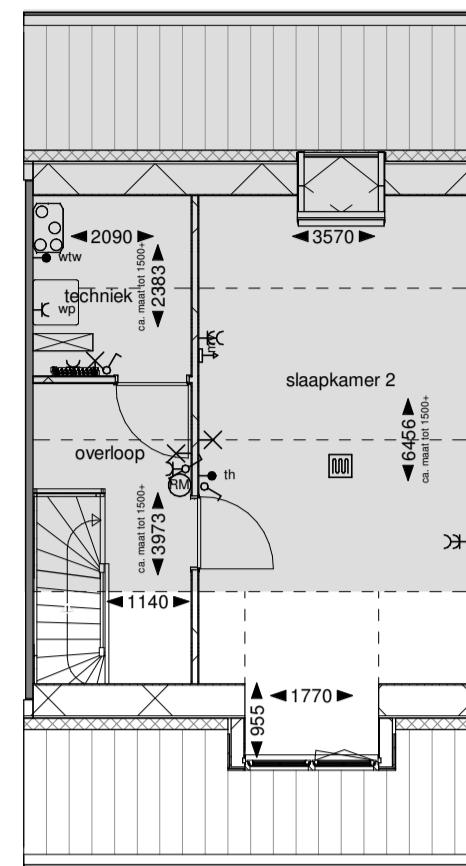

Eerste verdieping

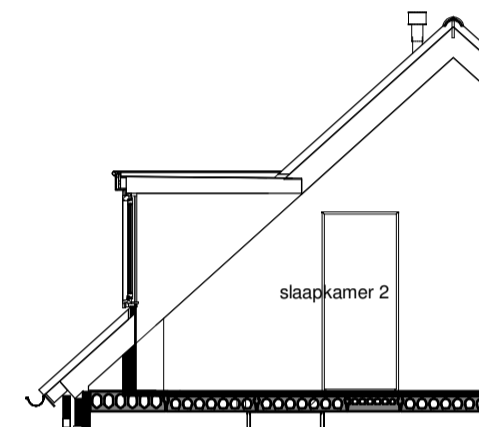

Doorsnede



Voorgevel

541: Dakramen 1140x1180mm

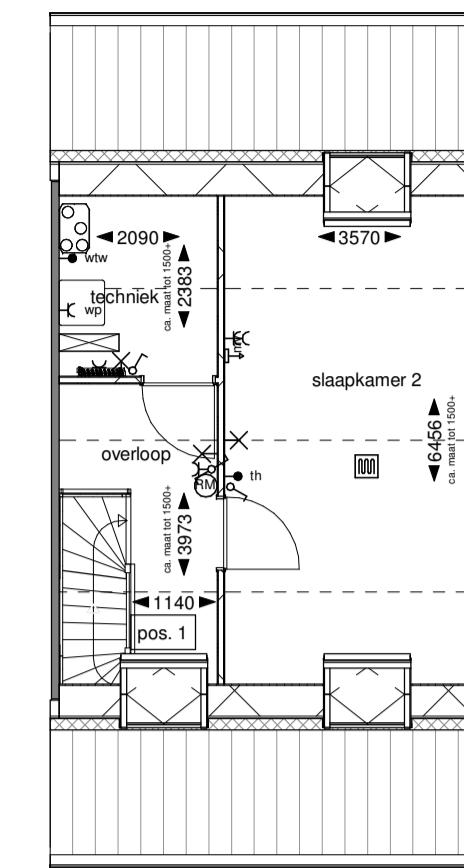

Eerste verdieping

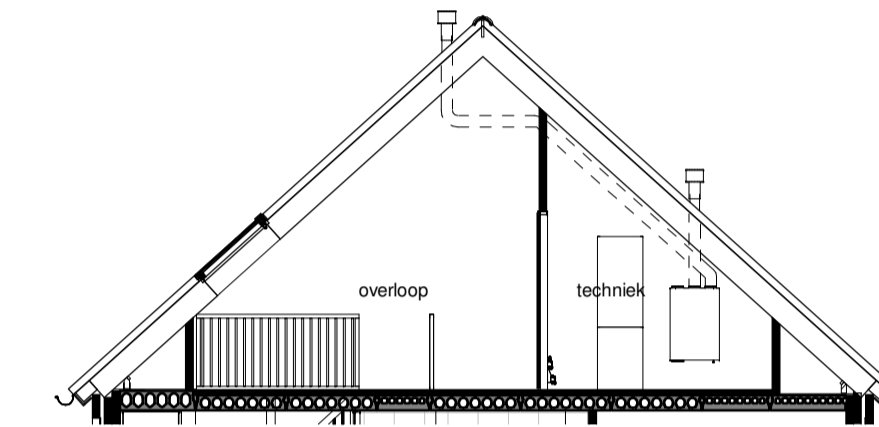

Doorsnede



Voorgevel

502: Uitbouw 2,4m

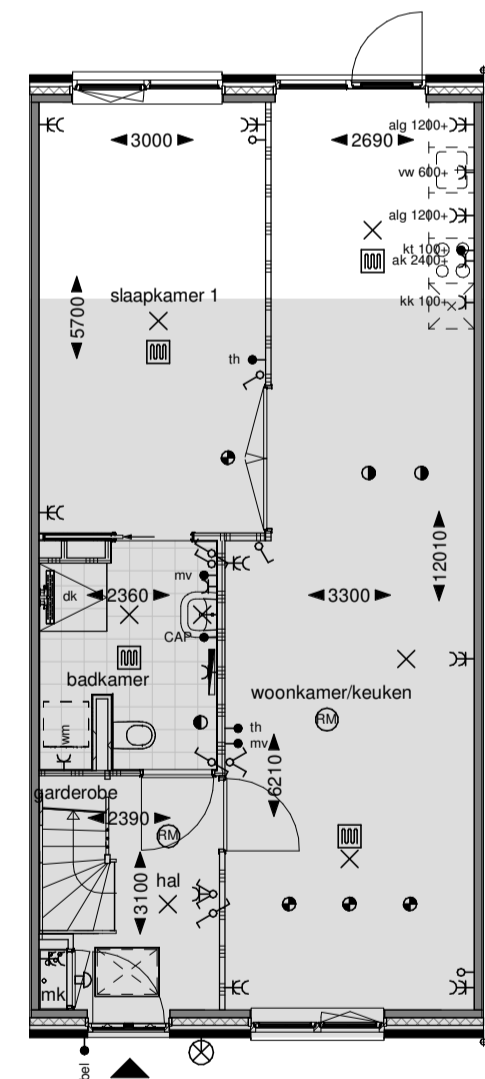

Begane grond

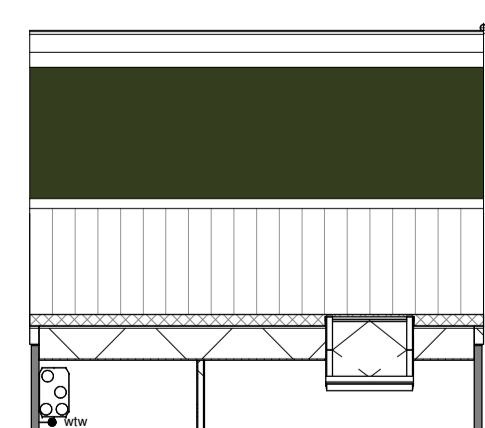

Eerste verdieping



Achtergevel

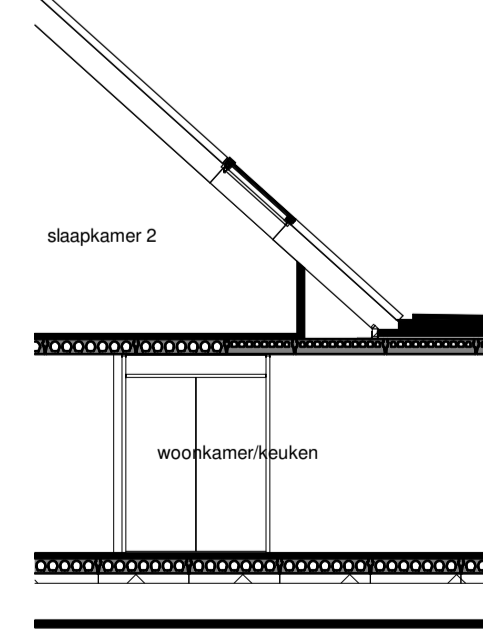

Doorsnede

532: Dakkapel achtergevel (b=2800mm)

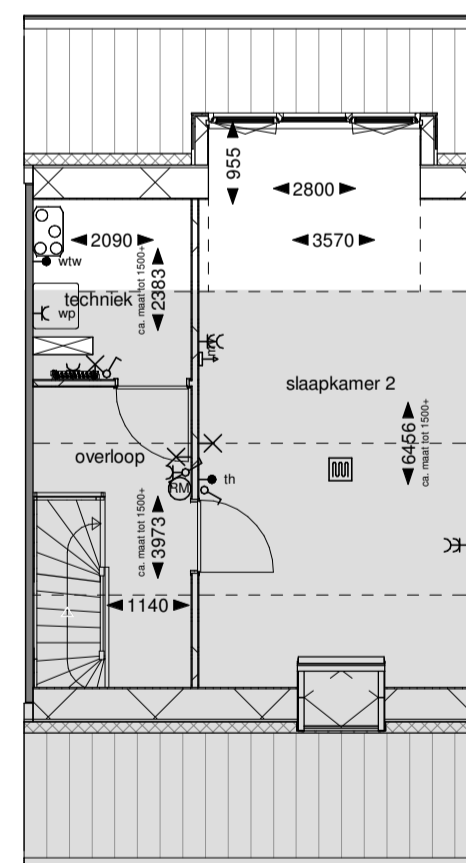

Eerste verdieping

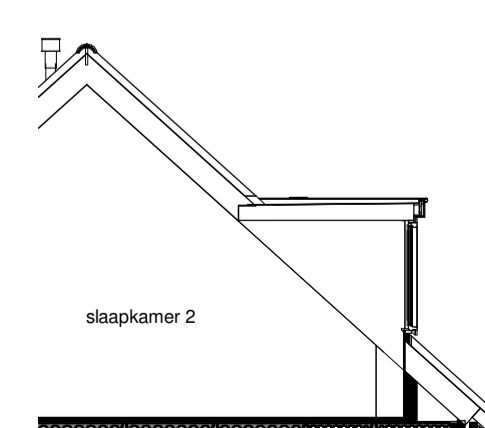

Doorsnede



Achtergevel

511: Dubbele deuren in slaapkamer

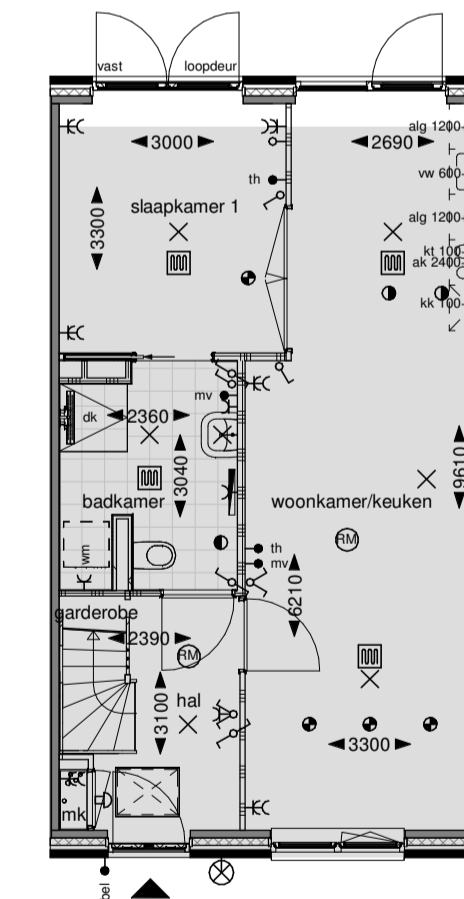

Begane grond



Achtergevel

optie	bouwnummer		
	13	16	18
optie mogelijk bij bouwnummer:			
501			
502			
511			
531			
532			
541			

De geveltegave van begane grond en 1e verdieping is een voorbeeldtegave en verschilt per bouwnummer

bolton Project: Het Slingerbos te Ophemert
 Bladomschrijving: Opties exterieur comfortwoning 6,0m
 Bladnummer: VT-07-OE

schaal: 1:100
 datum: 31-10-2023
 gewijzigd:
 A
 B
 C